

1492-SP Supplementary Protectors

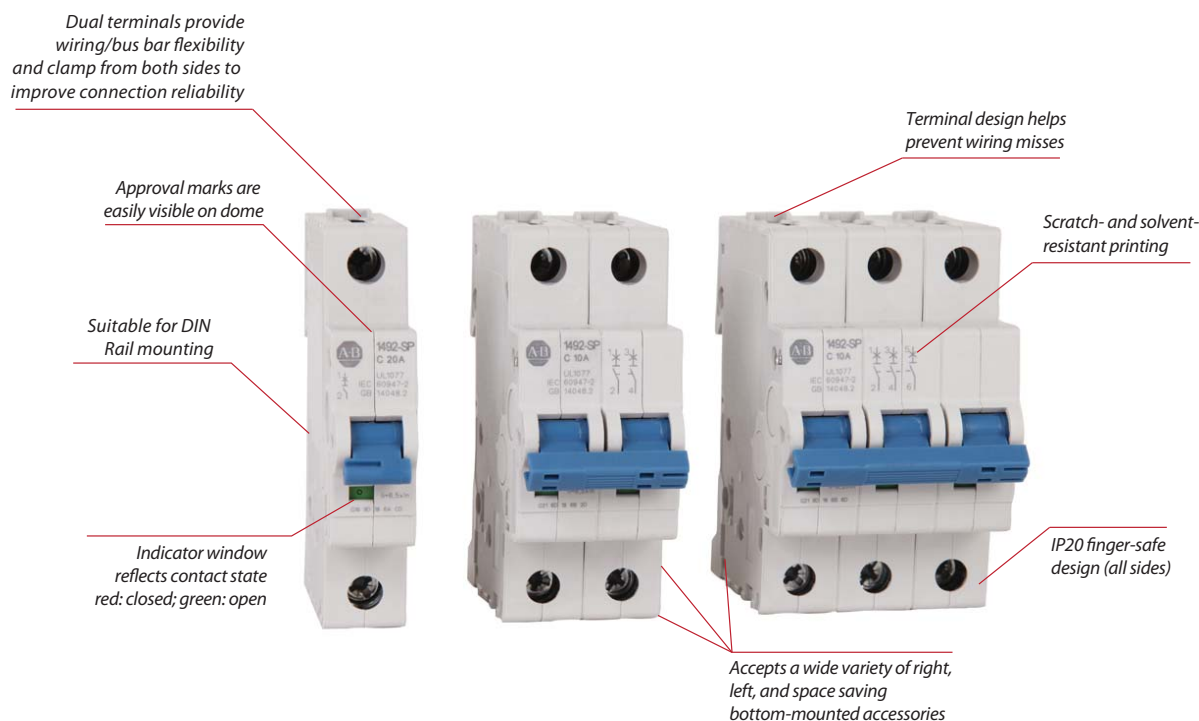

Bulletin 1492-SP thermal magnetic Supplementary Protectors provide overcurrent protection for equipment where branch circuit protection is already provided, or is not required. These devices are also Miniature Circuit Breakers as defined by IEC Standards.

These supplementary protectors are offered as a broad portfolio of pole variants, current ratings, and trip curves to match the appropriate level of protection for your application. They may be used with UL 508 Listed bus bars for convenience in panel assembly, a wide range of left-, right- and space saving bottom-mount accessories, and lock out attachments for safety during maintenance.

Features

- Current limiting
- Fast breaking time
- Existing installations can be easily upgraded to include an auxiliary using the bottom mounted auxiliary contact options, which require no DIN Rail space
- 40 °C calibration temperature (UL/CSA) eliminates need to derate for 508A industrial control panel installations
- Installation of up to six accessories on the same circuit breaker
- Dual terminals provide a more secure connection of up to four wires, or two wires and a bus bar
- Superior shock and vibration resistance to prevent nuisance tripping
- Terminal design helps prevent wiring misses by directing wires into the terminal openings, even while tightening
- Reversible line and load connections
- Single and multi-pole toggle mount lock out attachments available for Lockout/Tagout (LOTO)
- RoHS compliant and fully-recyclable device
- Suitable for extreme ambient conditions

1492-SP Supplementary Protectors

Rated Voltage	UL/CSA: Max. 480Y/277V AC IEC: U_e 230/400V AC
Interrupting Capacity	UL/CSA: 5...10 kA IEC: 15 kA
Current Ratings	0.5...63 A
Poles	1, 2, 3, 1+N, 3+N
Trip Curves	B, C, D
Standards Compliance	UL 1077 CSA C22.2 No. 235 EN 60947-2 GB 14048.2
Certifications	UL Recognized, File No. E65138 ★ CSA Certified, File No. 259391 ★ CE Marked CCC Certified VDE Certified RoHS Compliant

* 1+N and 3+N devices are not UL recognized or CSA certified.

Catalog Number Explanation

Note: Examples given in this section are for reference purposes. This basic explanation should not be used for product selection; some combinations may not produce a valid catalog number.

1492 - **SPM** **1** **C** **010** - **N**
a *b* *c* *d* *e*

a

Voltage Type	
Code	Description
SPM	AC Supplementary Protector

b

Poles	
Code	Description
1	1-Pole
2	2-Pole
3	3-Pole

c

Trip Curve	
Code	Trip Curve
B	Trip Curve B
C	Trip Curve C
D	Trip Curve D

d



Rated Current (I_n)	
Code	Current [A]
005	0.5
010	1
020	2
030	3
040	4
050	5
060	6
070	7
080	8
100	10
130	13
150	15
160	16
200	20
250	25
300	30
320	32
400	40
500	50
630	63

e

+ Neutral (available for 1+N and 3+N configurations)	
Code	Description
	Can be left blank
N	+ Neutral

Product Selection

1-Pole Supplementary Protectors

Photo/Wiring Diagram	Continuous Current Rating (I_n) [A]	Trip Curve B Resistive or Slightly Inductive $3 \dots 5 I_n$ Cat. No.	Trip Curve C Inductive $5 \dots 10 I_n$ Cat. No.	Trip Curve D Highly Inductive $10 \dots 20 I_n$ Cat. No.
	0.5	1492-SPM1B005	1492-SPM1C005	1492-SPM1D005
	1	1492-SPM1B010	1492-SPM1C010	1492-SPM1D010
	2	1492-SPM1B020	1492-SPM1C020	1492-SPM1D020
	3	1492-SPM1B030	1492-SPM1C030	1492-SPM1D030
	4	1492-SPM1B040	1492-SPM1C040	1492-SPM1D040
	5	1492-SPM1B050	1492-SPM1C050	1492-SPM1D050
	6	1492-SPM1B060	1492-SPM1C060	1492-SPM1D060
	7	1492-SPM1B070	1492-SPM1C070	1492-SPM1D070
	8	1492-SPM1B080	1492-SPM1C080	1492-SPM1D080
	10	1492-SPM1B100	1492-SPM1C100	1492-SPM1D100
	13	1492-SPM1B130	1492-SPM1C130	1492-SPM1D130
	15	1492-SPM1B150	1492-SPM1C150	1492-SPM1D150
	16	1492-SPM1B160	1492-SPM1C160	1492-SPM1D160
	20	1492-SPM1B200	1492-SPM1C200	1492-SPM1D200
	25	1492-SPM1B250	1492-SPM1C250	1492-SPM1D250
	30	1492-SPM1B300	1492-SPM1C300	1492-SPM1D300
	32	1492-SPM1B320	1492-SPM1C320	1492-SPM1D320
	 1-pole	40	1492-SPM1B400	1492-SPM1C400
50		1492-SPM1B500	1492-SPM1C500	1492-SPM1D500
63		1492-SPM1B630	1492-SPM1C630	1492-SPM1D630

Product Selection

1-Pole + Neutral Supplementary Protectors*

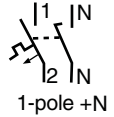
Photo/Wiring Diagram	Continuous Current Rating (I_n) [A]	Trip Curve B Resistive or Slightly Inductive $3...5 I_n$ Cat. No.	Trip Curve C Inductive $5...10 I_n$ Cat. No.	Trip Curve D Highly Inductive $10...20 I_n$ Cat. No.
	0.5	1492-SPM1B005-N	1492-SPM1C005-N	1492-SPM1D005-N
	1	1492-SPM1B010-N	1492-SPM1C010-N	1492-SPM1D010-N
	2	1492-SPM1B020-N	1492-SPM1C020-N	1492-SPM1D020-N
	3	1492-SPM1B030-N	1492-SPM1C030-N	1492-SPM1D030-N
	4	1492-SPM1B040-N	1492-SPM1C040-N	1492-SPM1D040-N
	5	1492-SPM1B050-N	1492-SPM1C050-N	1492-SPM1D050-N
	6	1492-SPM1B060-N	1492-SPM1C060-N	1492-SPM1D060-N
	7	1492-SPM1B070-N	1492-SPM1C070-N	1492-SPM1D070-N
	8	1492-SPM1B080-N	1492-SPM1C080-N	1492-SPM1D080-N
	10	1492-SPM1B100-N	1492-SPM1C100-N	1492-SPM1D100-N
	13	1492-SPM1B130-N	1492-SPM1C130-N	1492-SPM1D130-N
	15	1492-SPM1B150-N	1492-SPM1C150-N	1492-SPM1D150-N
	16	1492-SPM1B160-N	1492-SPM1C160-N	1492-SPM1D160-N
	20	1492-SPM1B200-N	1492-SPM1C200-N	1492-SPM1D200-N
	25	1492-SPM1B250-N	1492-SPM1C250-N	1492-SPM1D250-N
	30	1492-SPM1B300-N	1492-SPM1C300-N	1492-SPM1D300-N
		32	1492-SPM1B320-N	1492-SPM1C320-N
40		1492-SPM1B400-N	1492-SPM1C400-N	1492-SPM1D400-N
50		1492-SPM1B500-N	1492-SPM1C500-N	1492-SPM1D500-N
63		1492-SPM1B630-N	1492-SPM1C630-N	1492-SPM1D630-N

* 1+N configurations are not UL or CSA certified.

Product Selection

2-Pole Supplementary Protectors

Photo/Wiring Diagram	Continuous Current Rating (I_n) [A]	Trip Curve B Resistive or Slightly Inductive $3...5 I_n$ Cat. No.	Trip Curve C Inductive $5...10 I_n$ Cat. No.	Trip Curve D Highly Inductive $10...20 I_n$ Cat. No.
	0.5	1492-SPM2B005	1492-SPM2C005	1492-SPM2D005
	1	1492-SPM2B010	1492-SPM2C010	1492-SPM2D010
	2	1492-SPM2B020	1492-SPM2C020	1492-SPM2D020
	3	1492-SPM2B030	1492-SPM2C030	1492-SPM2D030
	4	1492-SPM2B040	1492-SPM2C040	1492-SPM2D040
	5	1492-SPM2B050	1492-SPM2C050	1492-SPM2D050
	6	1492-SPM2B060	1492-SPM2C060	1492-SPM2D060
	7	1492-SPM2B070	1492-SPM2C070	1492-SPM2D070
	8	1492-SPM2B080	1492-SPM2C080	1492-SPM2D080
	10	1492-SPM2B100	1492-SPM2C100	1492-SPM2D100
	13	1492-SPM2B130	1492-SPM2C130	1492-SPM2D130
	15	1492-SPM2B150	1492-SPM2C150	1492-SPM2D150
	16	1492-SPM2B160	1492-SPM2C160	1492-SPM2D160
	20	1492-SPM2B200	1492-SPM2C200	1492-SPM2D200
	25	1492-SPM2B250	1492-SPM2C250	1492-SPM2D250
	30	1492-SPM2B300	1492-SPM2C300	1492-SPM2D300
	32	1492-SPM2B320	1492-SPM2C320	1492-SPM2D320
40	1492-SPM2B400	1492-SPM2C400	1492-SPM2D400	
50	1492-SPM2B500	1492-SPM2C500	1492-SPM2D500	
63	1492-SPM2B630	1492-SPM2C630	1492-SPM2D630	

Product Selection

3-Pole Supplementary Protectors

Photo/Wiring Diagram	Continuous Current Rating (I_n) [A]	Trip Curve B Resistive or Slightly Inductive $3..5 I_n$ Cat. No.	Trip Curve C Inductive $5..10 I_n$ Cat. No.	Trip Curve D Highly Inductive $10..20 I_n$ Cat. No.
 <p>3-pole</p>	0.5	1492-SPM3B005	1492-SPM3C005	1492-SPM3D005
	1	1492-SPM3B010	1492-SPM3C010	1492-SPM3D010
	2	1492-SPM3B020	1492-SPM3C020	1492-SPM3D020
	3	1492-SPM3B030	1492-SPM3C030	1492-SPM3D030
	4	1492-SPM3B040	1492-SPM3C040	1492-SPM3D040
	5	1492-SPM3B050	1492-SPM3C050	1492-SPM3D050
	6	1492-SPM3B060	1492-SPM3C060	1492-SPM3D060
	7	1492-SPM3B070	1492-SPM3C070	1492-SPM3D070
	8	1492-SPM3B080	1492-SPM3C080	1492-SPM3D080
	10	1492-SPM3B100	1492-SPM3C100	1492-SPM3D100
	13	1492-SPM3B130	1492-SPM3C130	1492-SPM3D130
	15	1492-SPM3B150	1492-SPM3C150	1492-SPM3D150
	16	1492-SPM3B160	1492-SPM3C160	1492-SPM3D160
	20	1492-SPM3B200	1492-SPM3C200	1492-SPM3D200
	25	1492-SPM3B250	1492-SPM3C250	1492-SPM3D250
	30	1492-SPM3B300	1492-SPM3C300	1492-SPM3D300
	32	1492-SPM3B320	1492-SPM3C320	1492-SPM3D320
	40	1492-SPM3B400	1492-SPM3C400	1492-SPM3D400
	50	1492-SPM3B500	1492-SPM3C500	1492-SPM3D500
	63	1492-SPM3B630	1492-SPM3C630	1492-SPM3D630

Product Selection

3-Pole + Neutral Supplementary Protectors*

Photo/Wiring Diagram	Continuous Current Rating (I_n) [A]	Trip Curve B Resistive or Slightly Inductive $3 \dots 5 I_n$ Cat. No.	Trip Curve C Inductive $5 \dots 10 I_n$ Cat. No.	Trip Curve D Highly Inductive $10 \dots 20 I_n$ Cat. No.
	0.5	1492-SPM3B005-N	1492-SPM3C005-N	1492-SPM3D005-N
	1	1492-SPM3B010-N	1492-SPM3C010-N	1492-SPM3D010-N
	2	1492-SPM3B020-N	1492-SPM3C020-N	1492-SPM3D020-N
	3	1492-SPM3B030-N	1492-SPM3C030-N	1492-SPM3D030-N
	4	1492-SPM3B040-N	1492-SPM3C040-N	1492-SPM3D040-N
	5	1492-SPM3B050-N	1492-SPM3C050-N	1492-SPM3D050-N
	6	1492-SPM3B060-N	1492-SPM3C060-N	1492-SPM3D060-N
	7	1492-SPM3B070-N	1492-SPM3C070-N	1492-SPM3D070-N
	8	1492-SPM3B080-N	1492-SPM3C080-N	1492-SPM3D080-N
	10	1492-SPM3B100-N	1492-SPM3C100-N	1492-SPM3D100-N
	13	1492-SPM3B130-N	1492-SPM3C130-N	1492-SPM3D130-N
	15	1492-SPM3B150-N	1492-SPM3C150-N	1492-SPM3D150-N
	16	1492-SPM3B160-N	1492-SPM3C160-N	1492-SPM3D160-N
	20	1492-SPM3B200-N	1492-SPM3C200-N	1492-SPM3D200-N
	25	1492-SPM3B250-N	1492-SPM3C250-N	1492-SPM3D250-N
	30	1492-SPM3B300-N	1492-SPM3C300-N	1492-SPM3D300-N
	32	1492-SPM3B320-N	1492-SPM3C320-N	1492-SPM3D320-N
	40	1492-SPM3B400-N	1492-SPM3C400-N	1492-SPM3D400-N
	50	1492-SPM3B500-N	1492-SPM3C500-N	1492-SPM3D500-N
	63	1492-SPM3B630-N	1492-SPM3C630-N	1492-SPM3D630-N

* 3+N configurations are not UL or CSA certified.

Specifications

Electrical Ratings			
Poles	1, 2, 3, 1+N, 3+N		
Tripping characteristics	B, C, D		
Rated current (I_n)	0.5...63 A		
Rated frequency (f)	50/60 Hz		
Rated insulation voltage U_i per IEC/EN 60664-1	250 V AC (phase to ground), 440V AC (phase to phase)		
Overvoltage category	III		
Pollution degree	3		
Data per UL/CSA			
Rated voltage	1-pole	AC	277V AC
		DC	48V DC
	2-pole	AC	480Y/277V AC
		DC	96V DC
	3-pole	AC	480Y/277V AC
	Rated interrupting capacity per UL 1077		≤ 32 A: 10 kA (AC); > 32 A: 5 kA (AC); 0.5...63 A: 10 kA (DC)
Application		Supplementary protector for general use; application codes: TC1: [1P] OLO 277V AC, [2P;3P] OLO 480Y/277V AC; SC: 10 kA (0.5...32 A), 5 kA (35...63 A), U2 480Y/277V AC; FW3	
Reference temperature for tripping characteristics		40 °C	
Electrical endurance		6,000 ops (AC), 6,000 ops. (DC) 1 cycle (1s - ON, 9s - OFF)	
Data per IEC/EN 60947-2			
Rated operational voltage (U_e)	1-pole, 1+N		230V AC
	2-pole, 3-pole, 3+N		400V AC
Highest supply or utilization voltage (U_{max})	AC	1-pole, 1+N	253V AC
		2-pole, 3-pole, 3+N	440V AC
	DC★	1-pole	48V DC
		2-pole	96V DC
Min. operating voltage		12V AC, 12V DC	
Rated ultimate short-circuit breaking capacity (I_{cu})		15 kA	
Rated service short-circuit breaking capacity (I_{cs})		≤40 A: 11.25 kA >40 A: 7.5 kA	
Rated impulse withstand voltage U_{imp} . (1.2/50μs)		4 kV (test voltage 6.2kV at sea level, 5kV at 2,000m)	
Dielectric test voltage		2 kV (50/60Hz, 1 min.)	
Reference temperature for tripping characteristics		30 °C	
Electrical endurance		$I_n < 30A$: 20,000 ops (AC) $I_n \geq 30A$: 10,000 ops. (AC) 1 cycle (2s - ON, 13s - OFF, $I_n \leq 32A$), 1 cycle (2s - ON, 28s - OFF, $I_n > 32A$) 1,000 ops. (DC)	

★ IEC DC ratings self-declared.
♣ 2-pole/3-pole single pole load: TC2.

Mechanical Data		
Housing	Insulation group II, RAL 7035	
Indicator window	red ON/green OFF	
Protection degree per EN 60529	IP20, IP40 in enclosure with cover	
Mechanical endurance	20,000 operations	
Shock resistance per IEC/EN 60068-2-27	25 g - 2 shocks - 13 ms	
Vibration resistance per IEC/EN 60068-2-6	5g - 20 cycles at 5...150...5 Hz with load 0.8In	
Environmental		
Environmental conditions (damp heat) per IEC/EN 60068-2-30	28 cycles with 55°C/90-96% and 25°C/95-100%	
Ambient temperatureΔ	-25...+55 °C	
Storage temperature	-40...+70 °C	
Installation		
Terminal	Dual terminal	
Cross-section of wire ◆ – solid, stranded (front/back terminal slot)	35/35 mm ² 18...4/18...10 AWG	
Cross-section of wire – flexible (front/back terminal slot)	25/10 mm ²	
Multi-wire rating per UL, CSA	1 wire, 18...4 AWG 2-4 wires†, 18...10 AWG	
Cross-section of bus bars (back terminal slot)	10 mm ²	
Tightening torque	IEC	2.8 N•m
	UL/CSA	AWG 18...16: 13.3 in•lb. AWG 14...10: 17.7 in•lb. AWG 8...4: 39.8 in•lb.
Screwdriver	No. 2 Pozidrive	
Mounting	DIN rail (EN 60715, 35mm) with fast clip	
Mounting position	Any	
Supply	Optional	
Approximate Dimensions and Weight		
Pole dimension (H x D x W)	88 x 69 x 17.5 mm	
Pole weight	115 g (4.1 oz.)	
Combination with Auxiliary Elements		
Auxiliary contact	Yes	
Signal contact	Yes	
Shunt trip	Yes	

◆ 35mm² self-declared, not included in IEC/EN approval.
Δ Refer to the ambient temperature derating tables.
† Wires must be of like size and stranding. Up to two wires per terminal slot.

Power Loss Due to Current

Rated Current [A]	Power Loss Per Pole [W]	Rated Current [A]	Power Loss Per Pole [W]
0.5	1.4	13	2.3
1	1.4	15	2.4
2	1.8	16	2.5
3	1.6	20	2.5
4	1.8	25	3.2
5	1.9	30	3.5
6	2.0	32	3.7
7	1.1	40	4.5
8	1.5	50	4.5
10	2.1	63	5.4

Zero-stack Derating

The installation of several miniature circuit breaker side by side with rated current on all poles requires a correction factor to the rated current (not required if spacers are used).

No. of Adjacent Devices	Factor
1	1
2,3	0.9
4,5	0.8
≥ 6	0.75

Approximate Dimensions

Note: Dimensions are shown in millimeters (inches). Dimensions are not intended for manufacturing purposes.

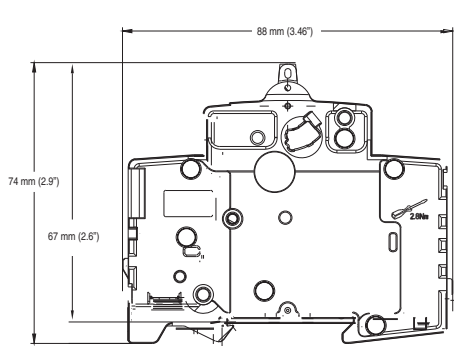

1-Pole

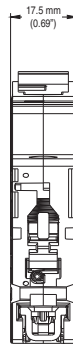

1-Pole

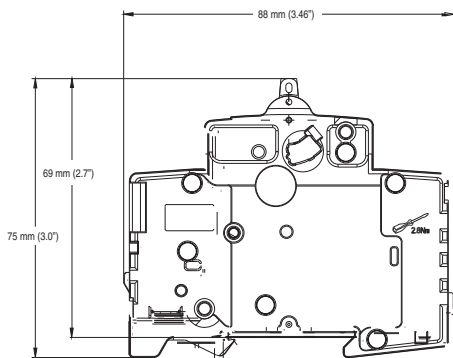

1 Pole + N, 2-, 3-, 3 Pole + N

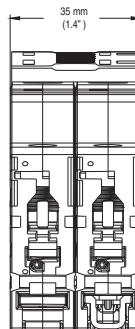

1 Pole + N, 2-Pole

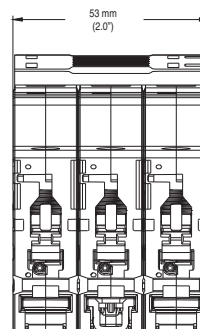

3-Pole

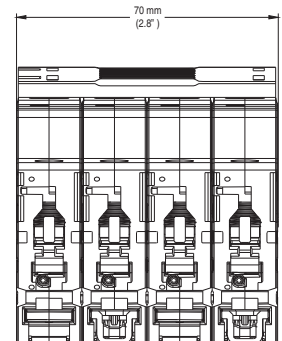

3-Pole + N

Ambient Temperature Derating

Note: Application below 0° C is for non-condensing atmosphere. Care should be taken for applications below 0 °C. These devices are not certified to operate correctly in the presence of ice.

Bulletin 1492-SP
 Temperature Derating, UL
 Reference temperature = 40 °C

Current Rating (A)	Ambient temperature (°C)									
	-25	-20	-10	0	10	20	30	40	50	55
0.5	0.6	0.6	0.6	0.6	0.6	0.5	0.5	0.5	0.5	0.5
1	1.2	1.2	1.2	1.1	1.1	1.1	1.0	1	1.0	0.9
2	2.5	2.4	2.4	2.3	2.2	2.1	2.1	2	1.9	1.9
3	3.7	3.7	3.6	3.4	3.3	3.2	3.1	3	2.9	2.8
4	5.0	4.9	4.7	4.6	4.4	4.3	4.1	4	3.9	3.8
5	6.2	6.1	5.9	5.7	5.6	5.4	5.2	5	4.8	4.7
6	7.4	7.3	7.1	6.9	6.7	6.4	6.2	6	5.8	5.7
7	8.7	8.6	8.3	8.0	7.8	7.5	7.3	7	6.7	6.6
8	9.9	9.8	9.5	9.2	8.9	8.6	8.3	8	7.7	7.6
10	12.4	12.2	11.9	11.5	11.1	10.7	10.4	10	9.6	9.4
13	16.1	15.9	15.4	14.9	14.4	14.0	13.5	13	12.5	12.3
15	18.6	18.3	17.8	17.2	16.7	16.1	15.6	15	14.4	14.2
16	19.8	19.6	19.0	18.4	17.8	17.2	16.6	16	15.4	15.1
20	24.8	24.4	23.7	23.0	22.2	21.5	20.7	20	19.3	18.9
25	31.0	30.6	29.6	28.7	27.8	26.9	25.9	25	24.1	23.6
30	37.2	36.7	35.6	34.4	33.3	32.2	31.1	30	28.9	28.3
32	39.7	39.1	37.9	36.7	35.6	34.4	33.2	32	30.8	30.2
40	49.6	48.9	47.4	45.9	44.4	43.0	41.5	40	38.5	37.8
50	62.0	61.1	59.3	57.4	55.6	53.7	51.9	50	48.2	47.2
63	78.2	77.0	74.7	72.3	70.0	67.7	65.3	63	60.7	59.5

Bulletin 1492-SP
 Temperature Derating, IEC
 Reference temperature = 30 °C

Current Rating (A)	Ambient temperature (°C)									
	-25	-20	-10	0	10	20	30	40	50	55
0.5	0.6	0.6	0.6	0.6	0.5	0.5	0.5	0.5	0.5	0.5
1	1.2	1.2	1.1	1.1	1.1	1.0	1	1.0	0.9	0.9
2	2.4	2.4	2.3	2.2	2.1	2.1	2	1.9	1.9	1.8
3	3.6	3.6	3.4	3.3	3.2	3.1	3	2.9	2.8	2.7
4	4.8	4.7	4.6	4.4	4.3	4.1	4	3.9	3.7	3.6
5	6.0	5.9	5.7	5.6	5.4	5.2	5	4.8	4.6	4.5
6	7.2	7.1	6.9	6.7	6.4	6.2	6	5.8	5.6	5.4
7	8.4	8.3	8.0	7.8	7.5	7.3	7	6.7	6.5	6.4
8	9.6	9.5	9.2	8.9	8.6	8.3	8	7.7	7.4	7.3
10	12.0	11.9	11.5	11.1	10.7	10.4	10	9.6	9.3	9.1
13	15.6	15.4	14.9	14.4	14.0	13.5	13	12.5	12.0	11.8
15	18.1	17.8	17.2	16.7	16.1	15.6	15	14.4	13.9	13.6
16	19.3	19.0	18.4	17.8	17.2	16.6	16	15.4	14.8	14.5
20	24.1	23.7	23.0	22.2	21.5	20.7	20	19.3	18.5	18.2
25	30.1	29.6	28.7	27.8	26.9	25.9	25	24.1	23.2	22.7
30	36.1	35.6	34.4	33.3	32.2	31.1	30	28.9	27.8	27.2
32	38.5	37.9	36.7	35.6	34.4	33.2	32	30.8	29.6	29.0
40	48.1	47.4	45.9	44.4	43.0	41.5	40	38.5	37.0	36.3
50	60.2	59.3	57.4	55.6	53.7	51.9	50	48.2	46.3	45.4
63	75.8	74.7	72.3	70.0	67.7	65.3	63	60.7	58.3	57.2

Tripping Characteristics

B Curve

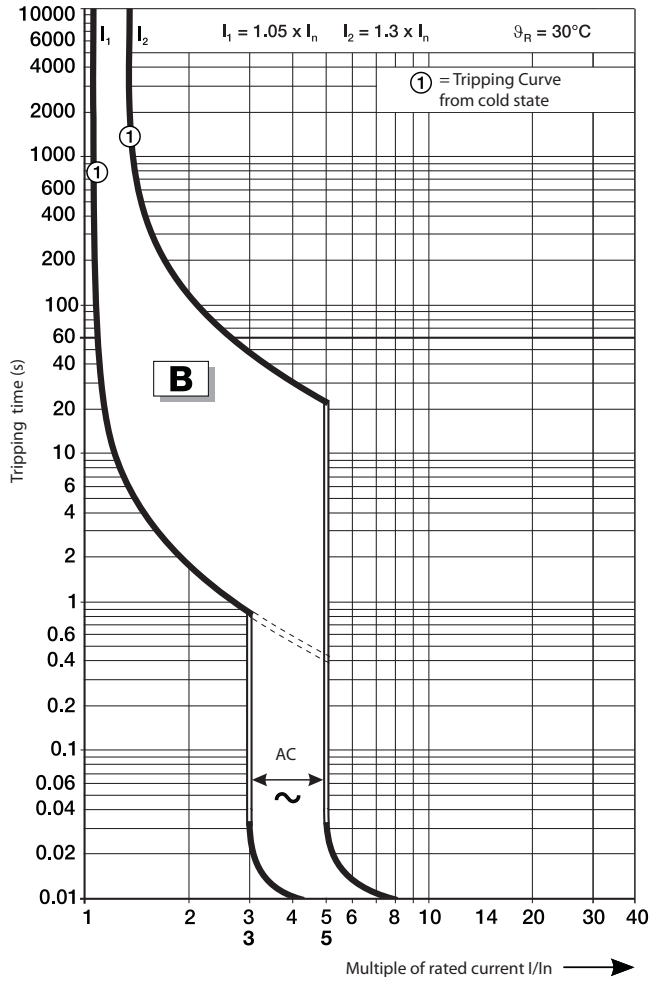

B and C Curve - 230/400V AC Let-through Energy

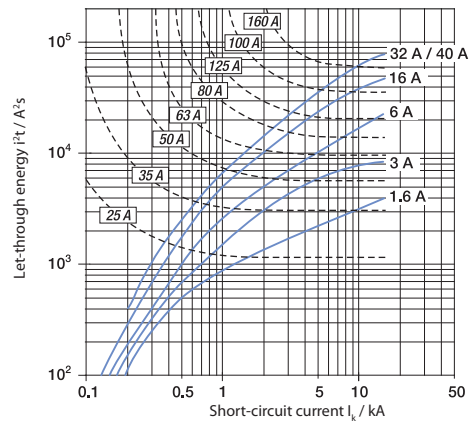
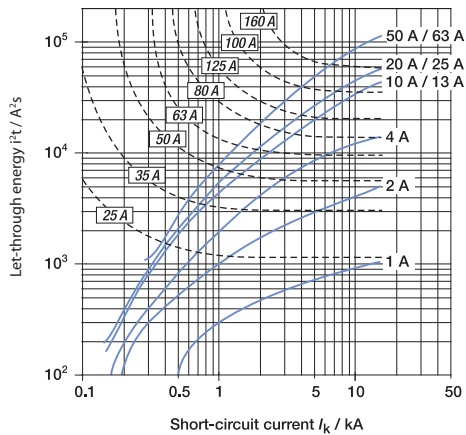

Tripping Characteristics

C Curve

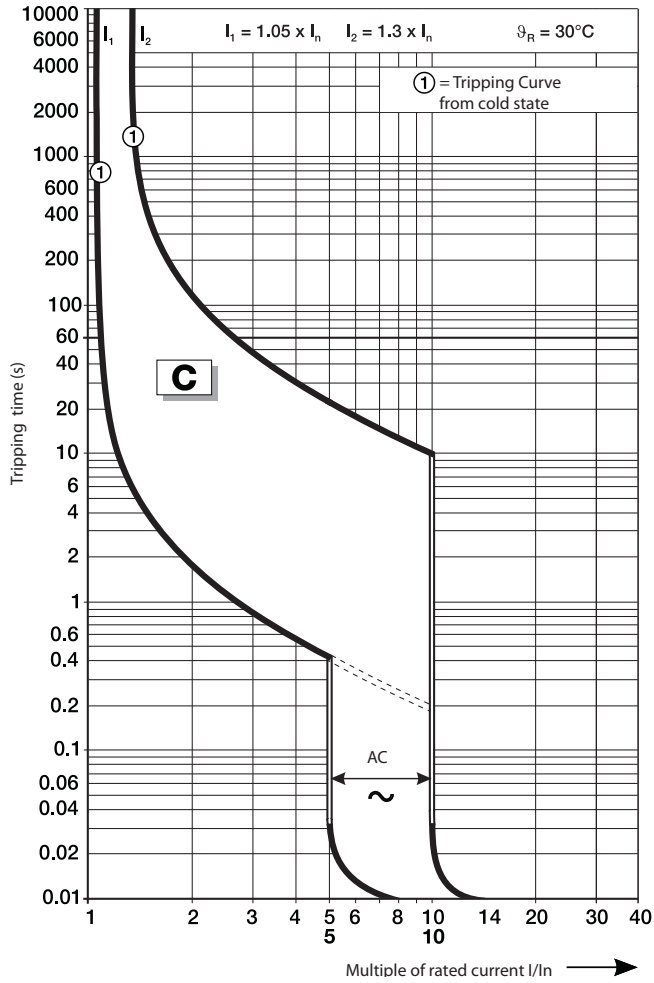

B and C Curve - 230/400V AC Let-through Energy

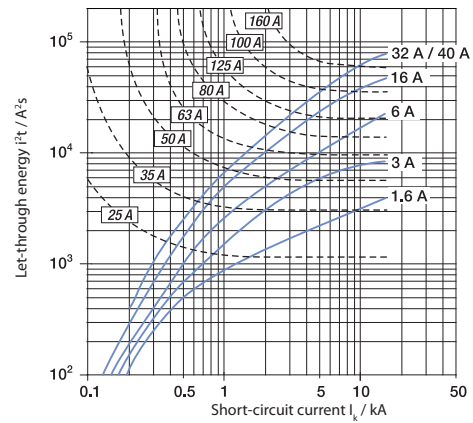
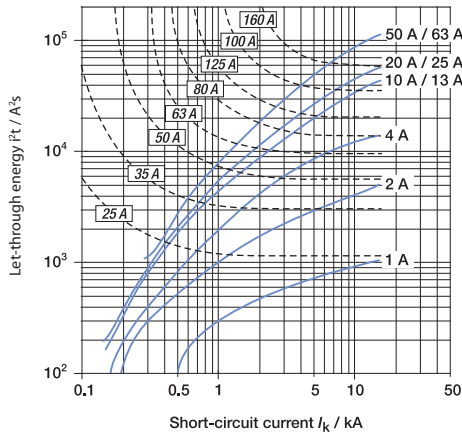

Tripping Characteristics

D Curve

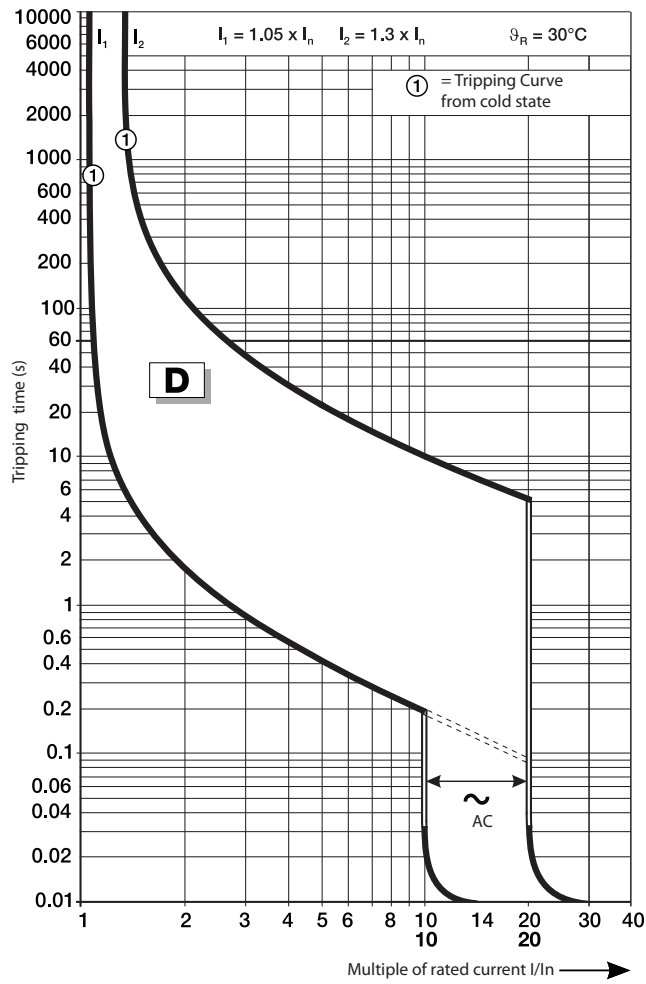



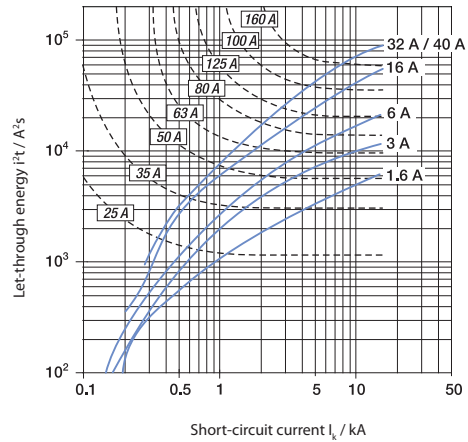
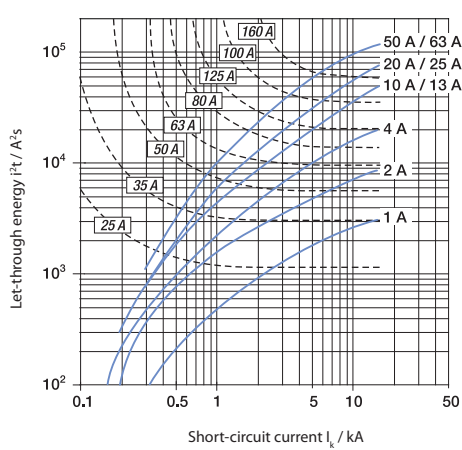









D Curve - 230/400V AC Let-through Energy



Accessories

Right Mount

Photo	Product Description ‡★△	Contacts	Standards	Certifications	UL/CSA Max. Current/Voltage	IEC Ratings Current/Voltage	Cat. No.
	Shunt Trip		UL 1077 CSA 22.2 No. 235	UL Recognized CSA Certified CE Marked	110...415V AC 110-250V DC	110...415V AC 110-250V DC	189-AST1
			UL 1077 CSA 22.2 No. 235	UL Recognized CSA Certified CE Marked	12...60V AC/DC	12...60V AC/DC	189-AST2
	Auxiliary/Signal Contact	1 N.O./N.C. (1 C.O.) 	UL 1077 CSA 22.2 No. 235 EN 60947-5-1 GB 14048.5	UL Recognized CSA Certified CE Marked VDE Certified CCC Certified	1A @ 480 VAC 2A @ 277 VAC 1.5A @ 125 VDC 2A @ 60 VDC 4A @ 24 VDC	2A @ 230 V (AC-14) 1A @ 400 V (AC-14) 1.5A @ 110 V (DC-12) 1A @ 220 V (DC-12) 4A @ 24 V (DC-13) 2A @ 60 V (DC-13)	189-ASCR3
	Auxiliary Contact	1 N.O./N.C. (1 C.O.) 	UL 1077 CSA 22.2 No. 235 EN 60947-5-1 GB 14048.5	UL Recognized CSA Certified CE Marked VDE Certified CCC Certified	1A @ 480 VAC 2A @ 277 VAC 1.5A @ 125 VDC 2A @ 60 VDC 4A @ 24 VDC	2A @ 230 V (AC-14) 1A @ 400 V (AC-14) 1.5A @ 110 V (DC-12) 1A @ 220 V (DC-12) 4A @ 24 V (DC-13) 2A @ 60 V (DC-13)	189-AR3
		1 N.O. + 1 N.C. 	UL 1077 CSA 22.2 No. 235 EN 60947-5-1 GB 14048.5	UL Recognized CSA Certified CE Marked VDE Certified CCC Certified	1A @ 400 VAC 2A @ 230 VAC 1A @ 50 VDC 2A @ 30V DC	2A @ 230 V (AC-14) 1A @ 400 V (AC-14) 2A @ 30V (DC-12) 1A @ 50 V (DC-12) 2A @ 30V (DC-13) 1A @ 50 V (DC-13)	189-AR11
		2 N.C. 	UL 1077 CSA 22.2 No. 235 EN 60947-5-1 GB 14048.5	UL Recognized CSA Certified CE Marked VDE Certified CCC Certified	1A @ 400 VAC 2A @ 230 VAC 1A @ 50 VDC 2A @ 30 VDC	2A @ 230 V (AC-14) 1A @ 400 V (AC-14) 2A @ 30V (DC-12) 1A @ 50 V (DC-12) 2A @ 30V (DC-13) 1A @ 50 V (DC-13)	189-AR02
		2 N.O. 	UL 1077 CSA 22.2 No. 235 EN 60947-5-1 GB 14048.5	UL Recognized CSA Certified CE Marked VDE Certified CCC Certified	1A @ 400 VAC 2A @ 230 VAC 1A @ 50 VDC 2A @ 30 VDC	2A @ 230 V (AC-14) 1A @ 400 V (AC-14) 2A @ 30V (DC-12) 1A @ 50 V (DC-12) 2A @ 30V (DC-13) 1A @ 50 V (DC-13)	189-AR20





‡ A maximum of one C.O. type signal contact, and two C.O. type auxiliary contacts **OR** three C.O. type auxiliary contacts may be installed with or without one shunt trip per 1492-SP.

★ A maximum of two 189-AR11, -AR02, or -AR20 auxiliary contacts may be installed per 1492-SP. They may not be combined with shunt trips or C.O. type contacts.

△ A maximum of four right mount accessories of any type may be installed per 1492-SP. The shunt trip must be mounted closest to 1492-SP, then the signal contact, then the auxiliary contact(s). For allowed combinations, and installation instructions please contact your local Rockwell Automation sales office or Allen-Bradley distributor.

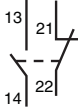

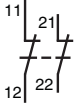
Accessories

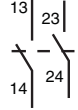
Left Mount

Photo	Product Description ★	Contacts	Standards	Certifications	UL/CSA Max. Current/Voltage	IEC Ratings Current/Voltage	Cat. No.
	Auxiliary Contact	1 N.O. + 1 N.C. 	EN 60947-5-1	CE Marked	—	2A @ 230 V (AC-14) 1A @ 400 V (AC-14) 1.5A @ 110 V (DC-12) 1A @ 220 V (DC-12) 4A @ 24 V (DC-13) 2A @ 60 V (DC-13)	189-AL11
		2 N.C. 	EN 60947-5-1	CE Marked	—	2A @ 230 V (AC-14) 1A @ 400 V (AC-14) 1.5A @ 110 V (DC-12) 1A @ 220 V (DC-12) 4A @ 24 V (DC-13) 2A @ 60 V (DC-13)	189-AL02
		2 N.O. 	EN 60947-5-1	CE Marked	—	2A @ 230 V (AC-14) 1A @ 400 V (AC-14) 1.5A @ 110 V (DC-12) 1A @ 220 V (DC-12) 4A @ 24 V (DC-13) 2A @ 60 V (DC-13)	189-AL20

★ Only one left mount auxiliary contact may be installed per 1492-SP.

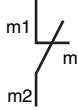

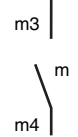
Bottom Mount

Photo	Product Description Δ	Contacts	Standards	Certifications‡	UL/CSA Max. Current/Voltage	IEC Ratings Current/Voltage	Cat. No.
	Auxiliary Contact	1 N.C. 	UL1077 CSA C22.2 No.235 EN 60947-5-1 GB 14048.5	UL Recognized CSA Certified CE Marked CCC Certified	2 A @ 230V AC 2 A @ 50V DC	2A @ 230 V (AC-14) 2A @ 30V (DC-12) 1A @ 50 V (DC-12) 2A @ 30 V (DC-13) 1A @ 50 V (DC-13)	189-AB01
		1 N.O. 	UL1077 CSA C22.2 No.235 EN 60947-5-1 GB 14048.5	UL Recognized CSA Certified CE Marked CCC Certified	2 A @ 230V AC 2 A @ 50V DC	2A @ 230 V (AC-14) 2A @ 30V (DC-12) 1A @ 50 V (DC-12) 2A @ 30 V (DC-13) 1A @ 50 V (DC-13)	189-AB10

Δ Only one bottom mount auxiliary contact may be installed per 1492-SP.

‡ Bottom mount auxiliaries show a CE Mark on the product instruction sheet and packaging, but not on the product itself.

Toggle Mount

Photo	Product Description	Cat. No.
	Lock-out attachment for 1-pole MCB	189-ALOA1
	Lock-out attachment for multi-pole MCB	189-ALOA2

Accessory Approximate Dimensions

Note: Dimensions are shown in millimeters (inches). Dimensions are not intended for manufacturing purposes.

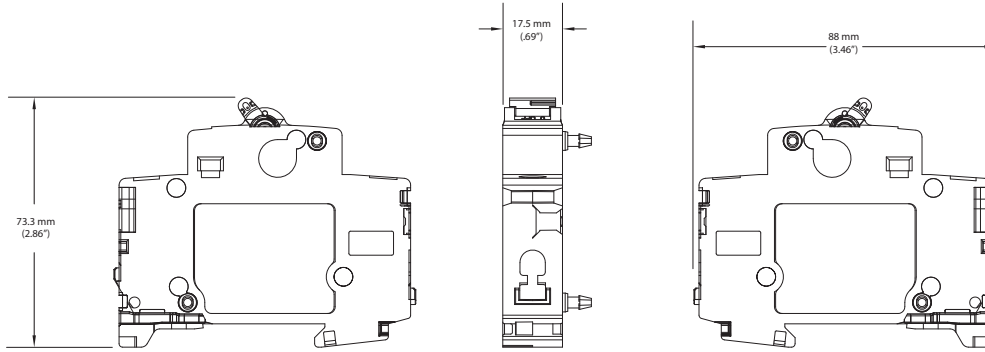

189-AST1 and 189-AST2

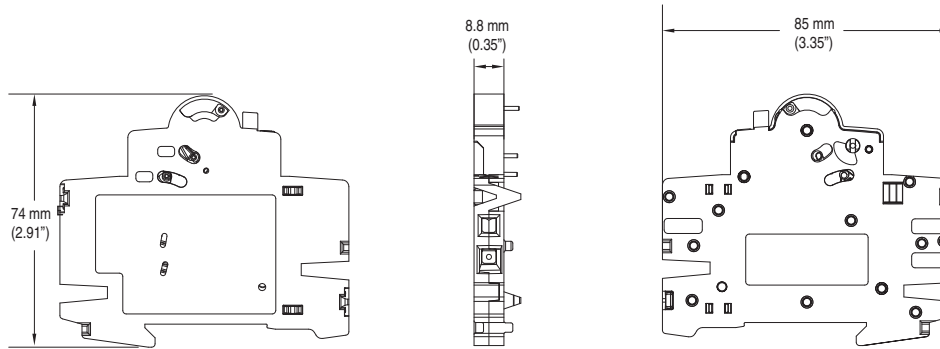

189-ASCR3

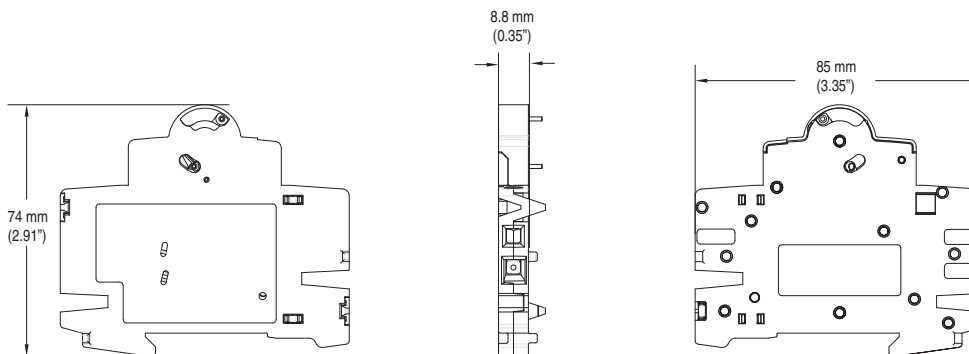

189-AR3

Accessory Approximate Dimensions

Note: Dimensions are shown in millimeters (inches). Dimensions are not intended for manufacturing purposes.

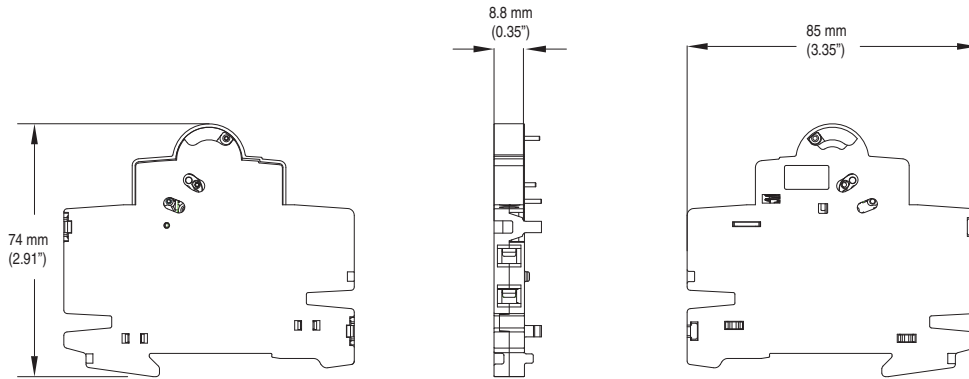

189-AR11, 189-AR02, 189-AR20

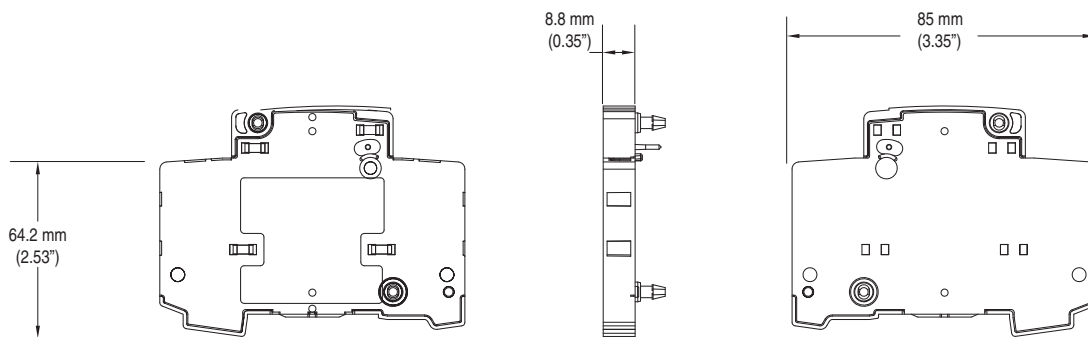

189-AL11, 189-AL02, and 189-AL20

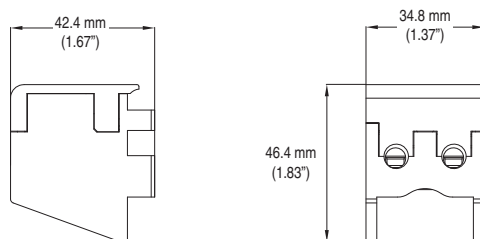

189-AB01 and 189-AB10

Bus Bars

1492-SP Bus Bars

Description	Pins	Rated Current [A] ‡	Pkg. Qty.	Cat. No. ★
1-Phase	57	100 A	1	1492-A1B1
	57	80 A	1	1492-A1B8
1-Phase with aux. contact	37	100 A	1	1492-A1B1H
	37	80 A	1	1492-A1B8H
2-Phase	56	100 A	1	1492-A2B1
	56	80 A	1	1492-A2B8
2-Phase with aux. contact	46	100 A	1	1492-A2B1H
	46	80 A	1	1492-A2B8H
3-Phase	57	100 A	1	1492-A3B1
	57	80 A	1	1492-A3B8
3-Phase with aux. contact	48	100 A	1	1492-A3B1H
	48	80 A	1	1492-A3B8H

★ cULus, UL508, EN 60947-1, CE Marked

‡ Refer to the diagrams below for Feeder Terminal & Bus Bar Current Distribution

1492-SP Bus Bar Accessories

Description	Pkg. Qty.	Cat. No. ★
Terminal Power Feed, 35 mm ² , straight lug	10	1492-AAT1S
Terminal Power Feed, 35 mm ² , offset lug, low profile	10	1492-AAT1LP
Dedicated Power Feed, 50 mm ²	10	1492-AAT2
End Cover for 1-phase bus bar	10	1492-A1E
End Cover for 2- or 3-phase bus bar	10	1492-AME
Protective Shroud for unused pins	10	1492-AAP

★ cULus, UL508, EN 60947-1, CE Marked

Feeder Terminal & Bus Bar Current Distribution

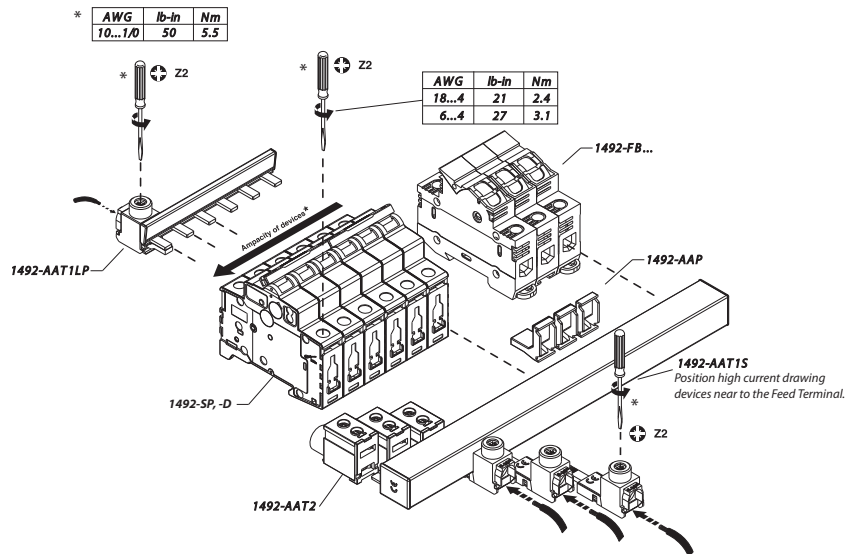
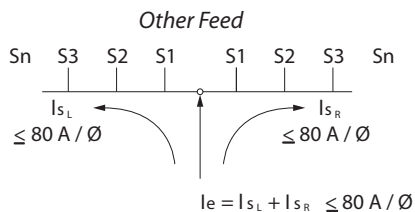
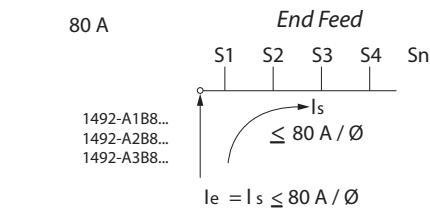
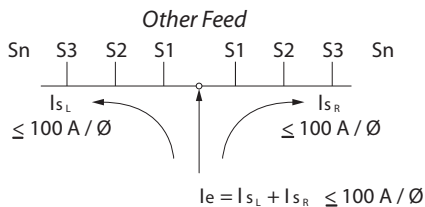
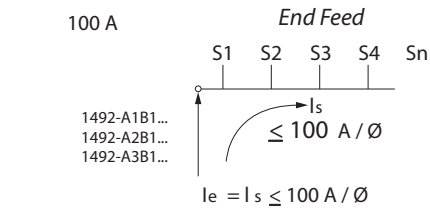

Bus Bar Approximate Dimensions

Note: Dimensions are shown in millimeters (inches). Dimensions are not intended for manufacturing purposes.

1-Phase Bus Bars

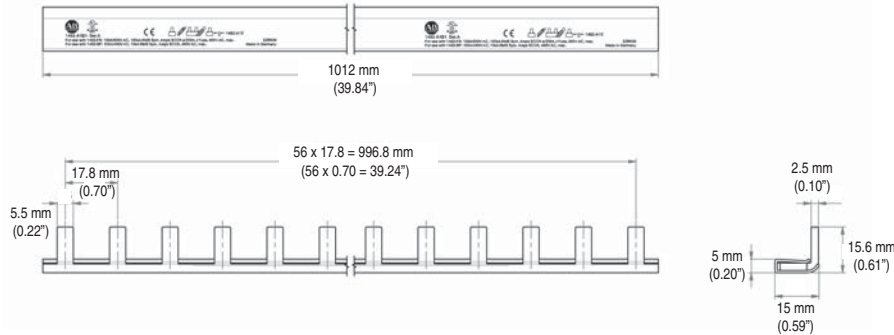

1492-A1B1

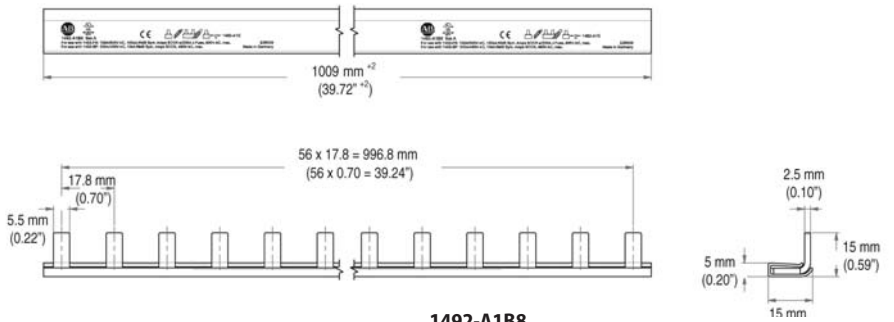

1492-A1B8

1-Phase Bus Bars, with Auxiliary Contact

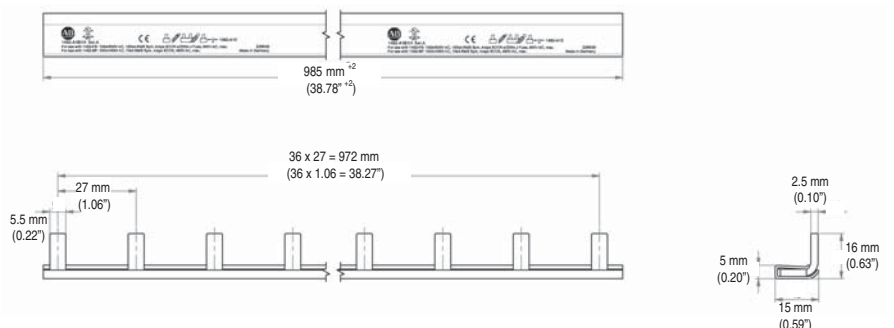

1492-A1B1H

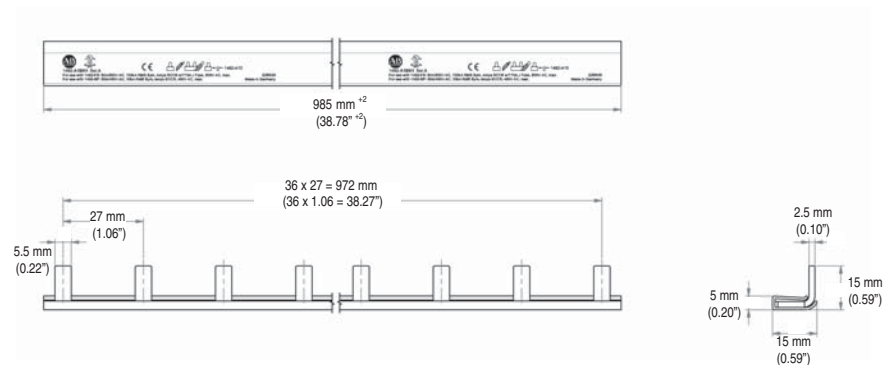

1492-A1B8H

Bus Bar Approximate Dimensions

Note: Dimensions are shown in millimeters (inches). Dimensions are not intended for manufacturing purposes.

2-Phase Bus Bars

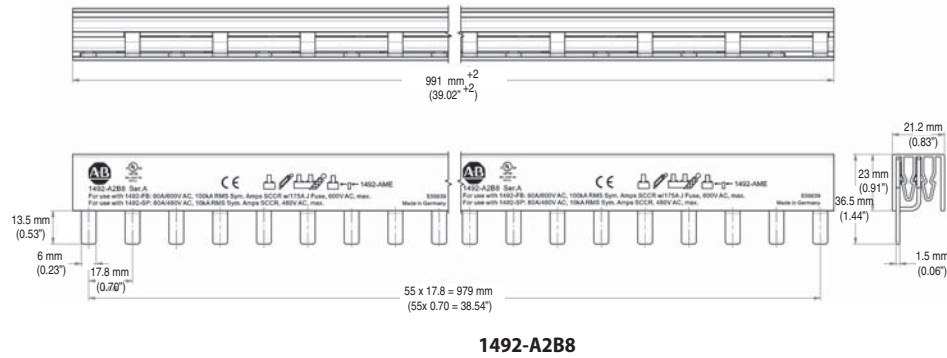
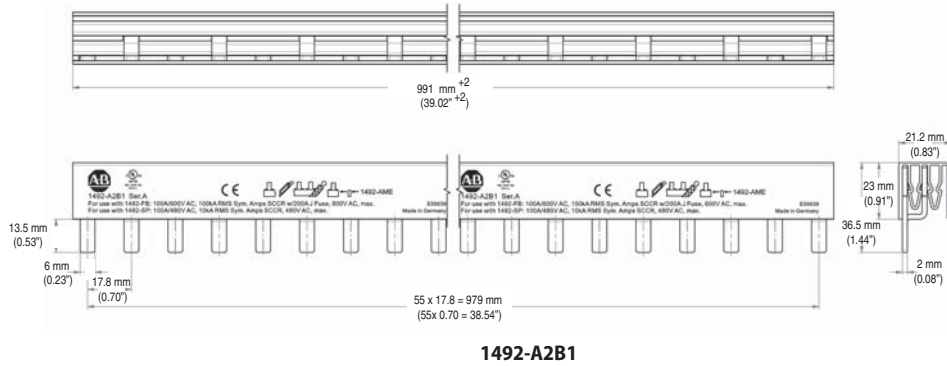

2-Phase Bus Bars, with Auxiliary Contact

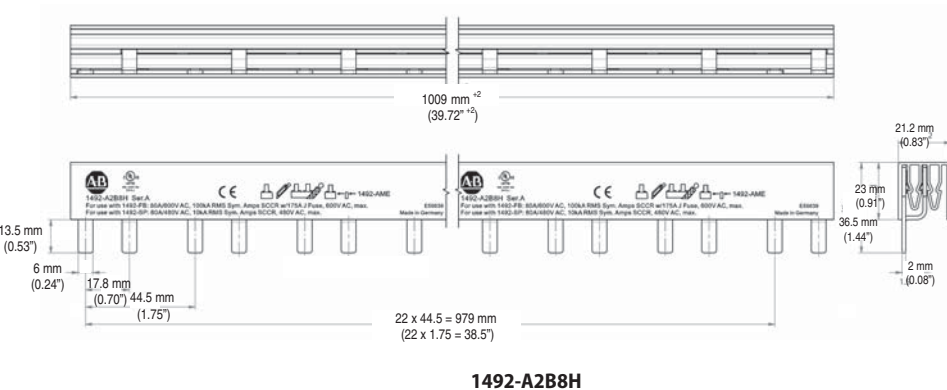
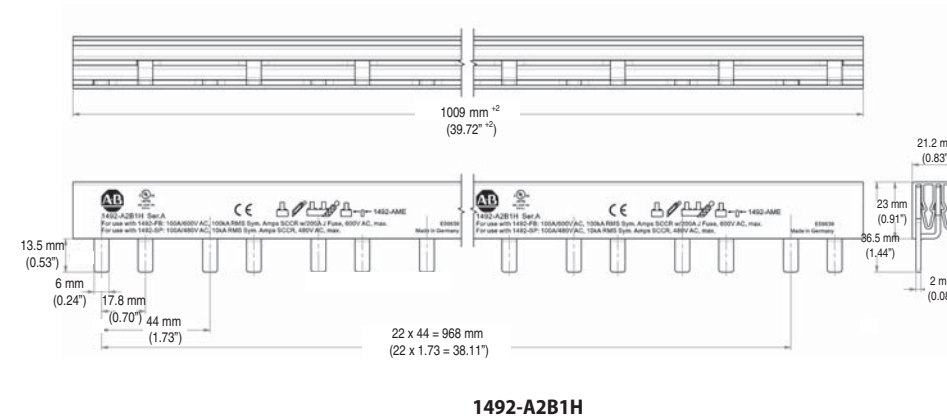

Bus Bar Approximate Dimensions

Note: Dimensions are shown in millimeters. Dimensions are not intended for manufacturing purposes.

3-Phase Bus Bars

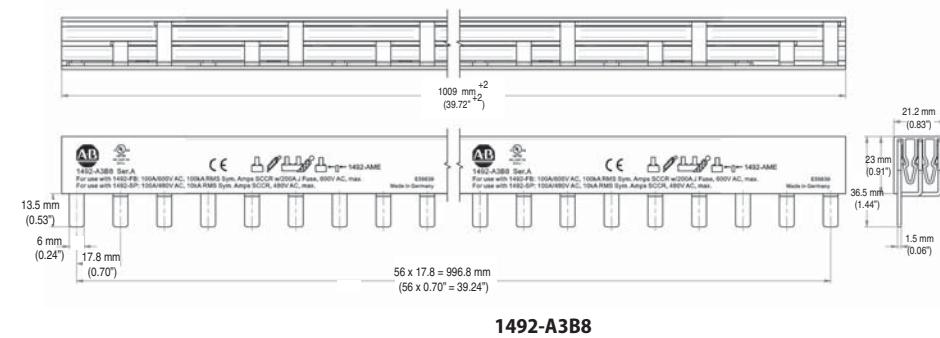
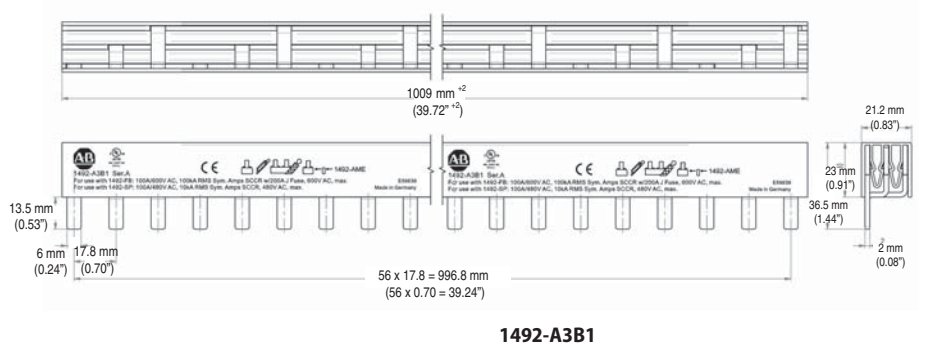

3-Phase Bus Bars, with Auxiliary Contact

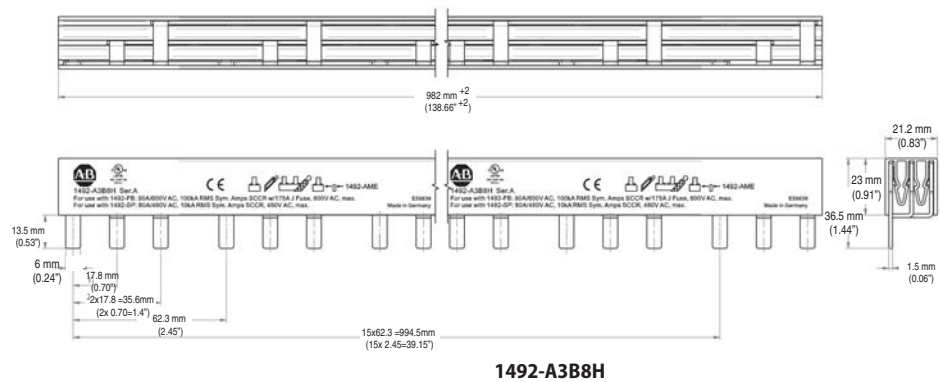
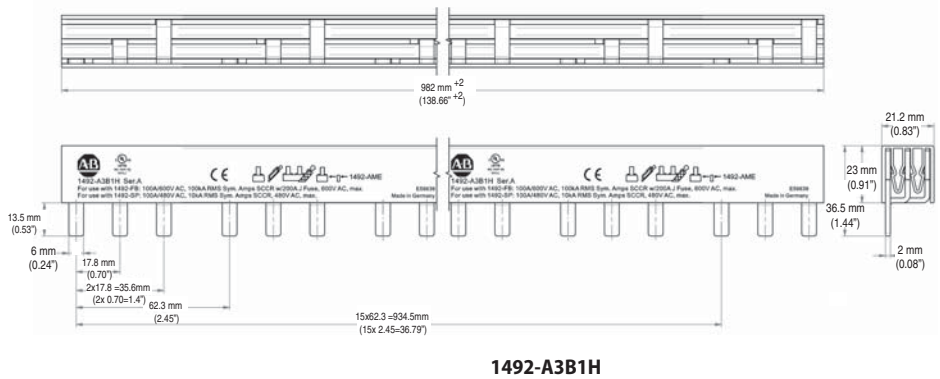

Bus Bar Accessory Approximate Dimensions

Note: Dimensions are shown in millimeters. Dimensions are not intended for manufacturing purposes.

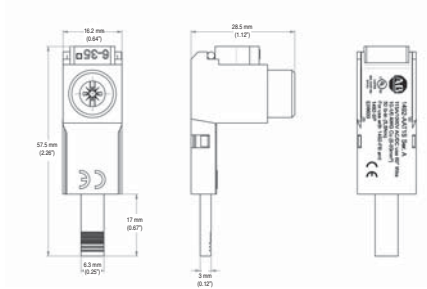

1492-AAT1S

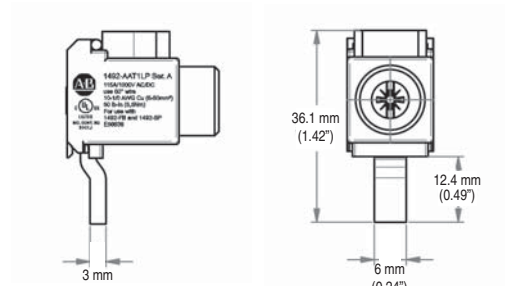
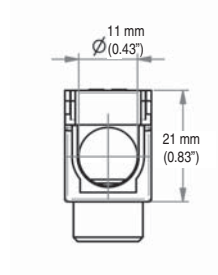

1492-AAT1LP

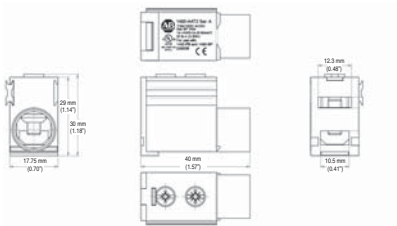

1492-AAT2

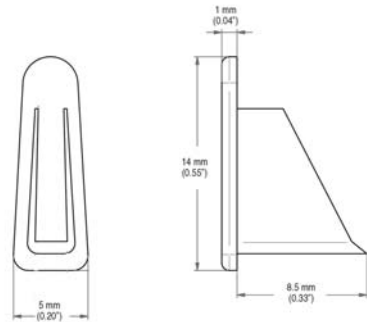

1492-A1E

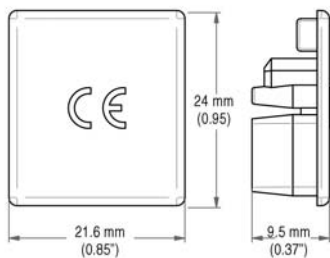

1492-AME

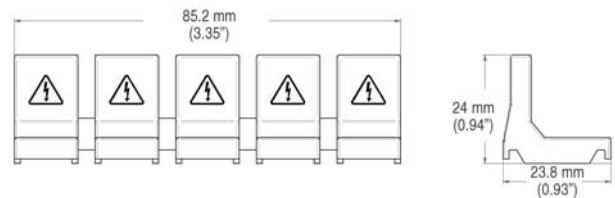

1492-AAP